

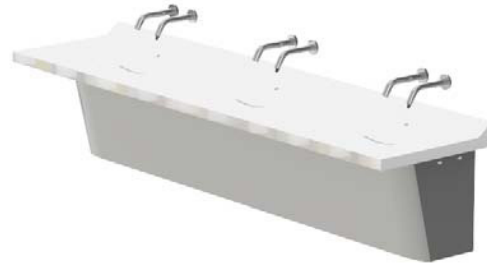

Model Z5003.03

Sundara® Drift Triple Basin Hand Washing System

TAG _____



PATENT(S) PENDING

Product Description

Designed for modern commercial restrooms, the Sundara system delivers a superior user experience in both form and function. Crafted by world-class industrial designers Sundara combines seamless basin designs with curated faucets and soap dispensers, delivering a complete, easy to install hand washing solution.

Architect/Engineer Specification

Sundara® Drift triple basin lavatory system manufactured by Zurn Industries. Lavatory shall be mounted at standard height to conform with ANSI, UFAS, TAS and ADA Accessibility Standards. Counter and integral basin to be constructed of Sundara® solid surface resin with aluminum trihydrate and other additives conforming to CSAB45.5/Z124 and IGC 156 standards. Shroud enclosure is constructed of satin finished type 304, 18 gage stainless steel designed for easy access with vandal resistant hardware. Lavatory is furnished complete with 0.5 gpm flow sensor operated faucet (specify model) and optional liquid soap dispenser (specify model), 1/2" quarter turn supply stops, 3/8" flexible supply risers, chrome 1 1/4" tail piece, and chrome 1 1/4" p-trap for complete system operation.

Product Features

- Sundara® engineered solid surface
- Available in multiple colors
- Matched soap and faucet options
- Stainless steel ADA compliant shroud
- Non-splash basin design
- Left or right side integrated soap hole
- Zurn One orders include all required components for installation and Z8701-9LC-PC P trap along with Z8800-XL-LR-8860-16-PC supply kit with 16" flexible supplies
- Provided with chrome finish faucet, soap dispenser and grid drain. Available in alternate finishes
- Provided with mounting bracket and wall bracket with necessary hardware for ease of installation
- Integral overflow

Standards Compliance

- ADA Compliant
- Lead Free Compliant
- CSA B45.5 / IAPMO Z124
- IAPMO IGC 156
- Texas Accessibility Standard (TAS)
- ASME A112.18.1/CSA B125.1
- ASME A112.18.2/CSA B125.2 (Applicable to Waste Fitting)
- ASME A112.6.1M (applicable to Carrier)
- NSF/ANSI 61-9 (applicable to Faucet)



Meets the American Disabilities Guidelines and ANSI A117.1 requirements when lavatory is installed 34" [864mm] from finished floor.

In Canada - Consult local codes and standards.

All dimensions and specifications are subject to change without notice.



Model Z5003.03

Sundara® Drift Triple Basin Hand Washing System

Options:

Faucet (must select one)



Z6957-XL-N



Z6952-XL-F

Soap Dispenser (must select one)



Z6957-SD



Z6952-SD

No Soap

Mixing Option

- No Mixing
- MV Temperature Mixing Valve
- TMV Thermostatic Mixing Valve for Multiple Faucets
- TMV-1 Thermostatic Mixing Valve for Single Faucet

Colors (must select one)

- White (01)
- Snow (02)
- Sea Shell (03)
- HighCliffe (04)
- Sand Storm (05)
- Alluvium (06)
- Frost (07)

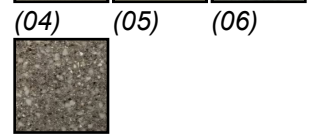
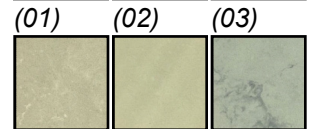
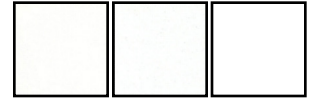

Alternate Finishes

(Applies to sensor operated faucet, corresponding soap and grid drain)

- BN : Brushed Nickel (01)
- PN : Polished Nickel (02)
- PB : Polished Brass (03)

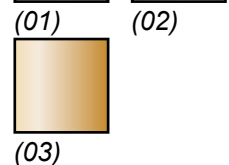

Recommended Hanging Apparatus

Z1240-EZR Sundara lavatory carrier

Meets the American Disabilities Guidelines and ANSI A117.1 requirements when lavatory is installed 34" [864mm] from finished floor.

In Canada - Consult local codes and standards.

All dimensions and specifications are subject to change without notice.



Model Z5003.03

Sundara® Drift Triple Basin Hand Washing System

TOP VIEW

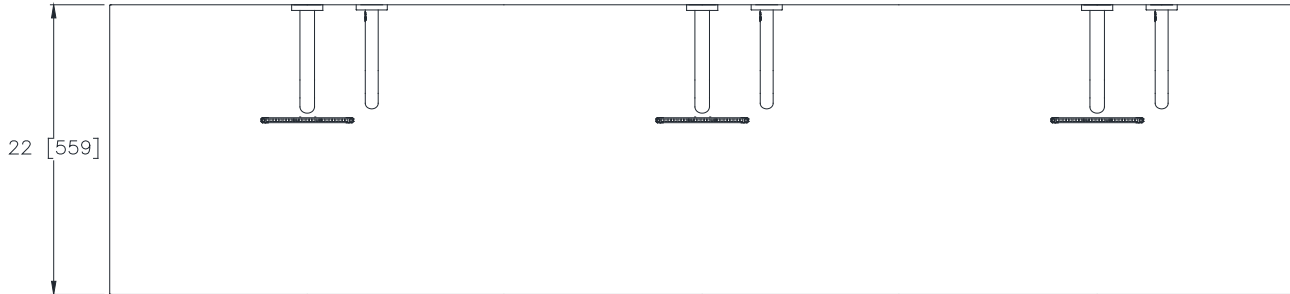

FRONT VIEW

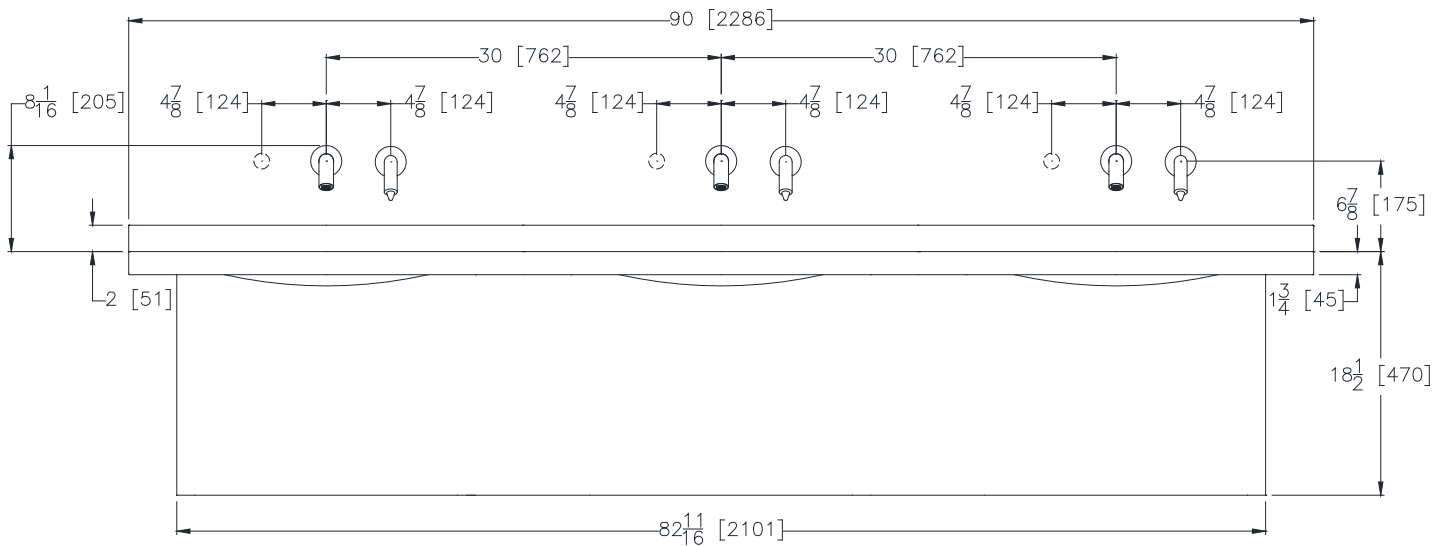

Meets the American Disabilities Guidelines and ANSI A117.1 requirements when lavatory is installed 34" [864mm] from finished floor.

In Canada - Consult local codes and standards.

All dimensions and specifications are subject to change without notice.



Model Z5003.03

Sundara® Drift Triple Basin Hand Washing System

SIDE VIEW

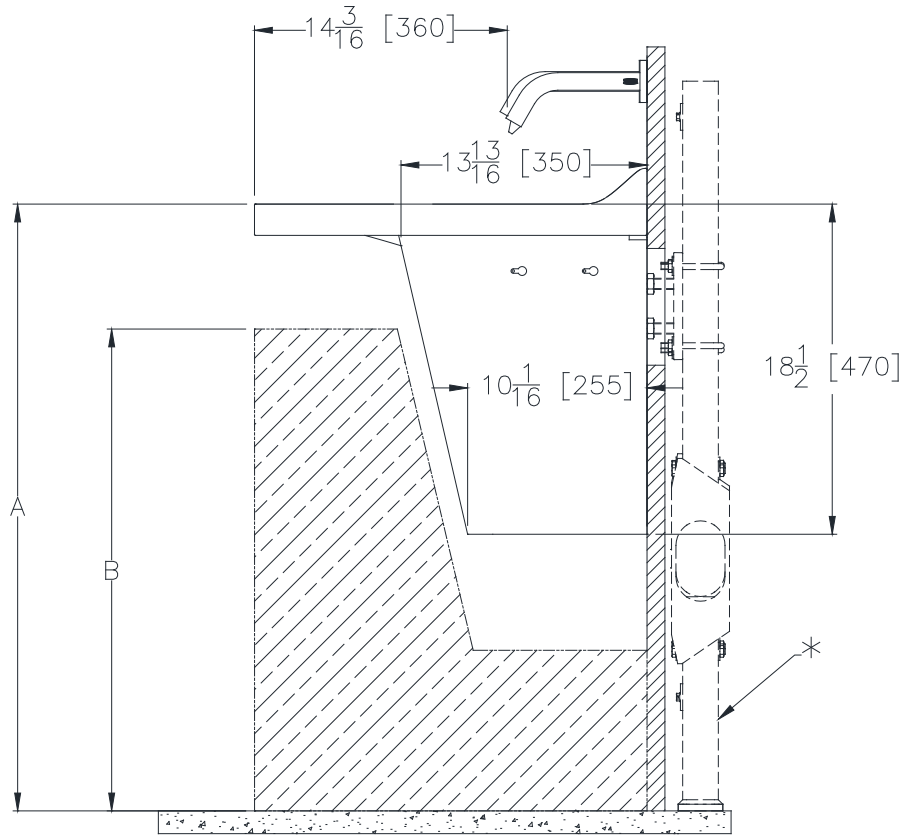

**Shown with optional Sundara Z1240-EZR-WL*

	ADA/TAS Regular Height	ADA/TAS Juvenile Height (Children 6-12 years)	CSA Regular Height	OBC Regular Height
A	34" (863mm)	31" (787mm)	32 1/4 - 33 13/16" (820 - 860mm)	33" (838mm)
B	27" (686mm)	24" (610mm)	26 13/16" (680mm) min.	27" (686mm)

Meets the American Disabilities Guidelines and ANSI A117.1 requirements when lavatory is installed 34" [864mm] from finished floor.

In Canada - Consult local codes and standards.

All dimensions and specifications are subject to change without notice.



Model Z5003.03

Sundara® Drift Triple Basin Hand Washing System

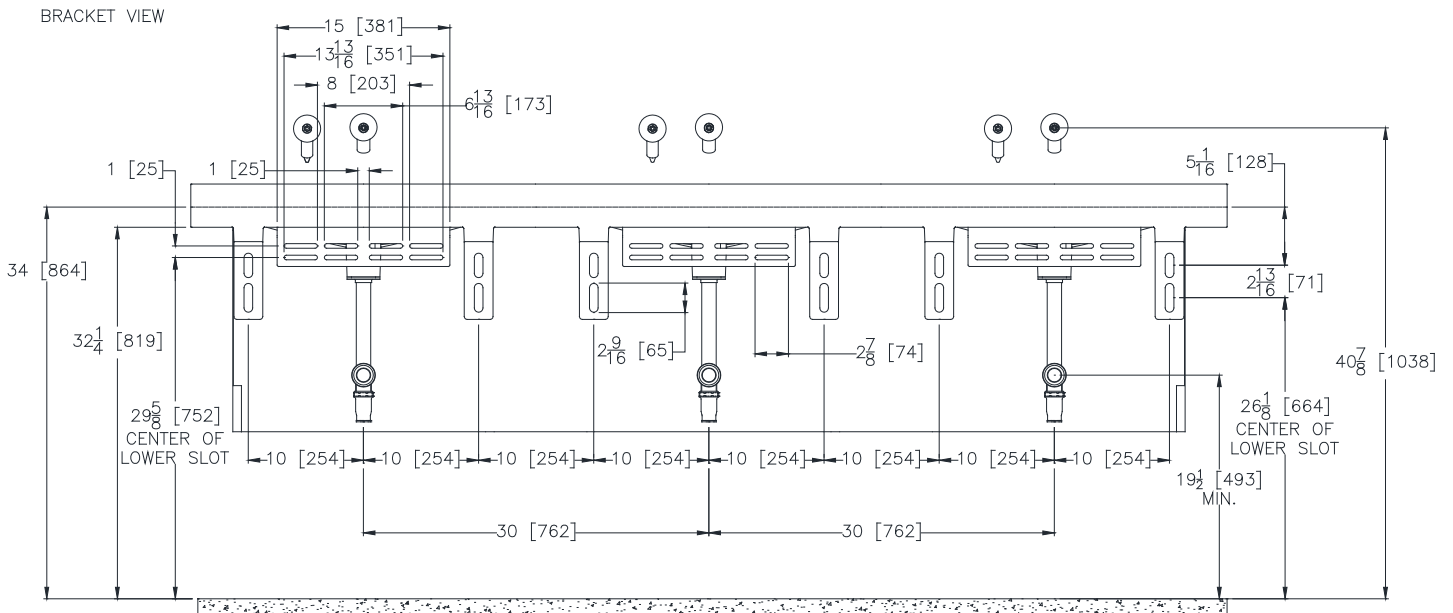

Installing the P-trap outlet lower than 19.5" from the finished floor will prevent the vandal shroud from being installed.

Meets the American Disabilities Guidelines and ANSI A117.1 requirements when lavatory is installed 34" [864mm] from finished floor.

In Canada - Consult local codes and standards.

All dimensions and specifications are subject to change without notice.