

NOTES:

1. FOR HYDROMECHANICAL APPLICATIONS ONLY.
2. ALL PROCEPTOR UNITS ARE MANUFACTURED WITH FIBERGLASS REINFORCED PLASTICS. PHYSICAL CHARACTERISTICS AND THICKNESS: POLYESTER RESIN AND E GLASS. MINIMUM THICKNESS 1/4" WALL AND 3/8" TOP AND BOTTOM BOWLS.
3. ALL PROCEPTOR UNITS ARE TO BE INSTALLED IN ACCORDANCE WITH THE MANUFACTURER'S INSTALLATION INSTRUCTION.
4. STANDARD PIPING IS SCH. 40 PVC.
5. GMC 50 - 300 UNITS COME STANDARD WITH 4" INLET AND OUTLET
6. EXTENSION COLLAR TO BE ORDERED TO MEET FINISHED GRADE, CUT ON SITE FOR FINAL ADJUSTMENT AND CAULKED WITH SIKAFLEX BY CONTRACTOR FOR WATERTIGHT SEAL.
7. COVERS AVAILABLE FOR H20 TRAFFIC LOADING, PEDESTRIAN LOADING OR ABOVE GROUND INSTALLATION.
8. CONSULT GREEN TURTLE FOR OTHER SIZES.
9. LIFETIME WARRANTY AGAINST LEAKS, AND STRUCTURAL FAILURE DUE TO MANUFACTURING DEFECTS.

CONSULT LOCAL AUTHORITIES FOR MINIMUM SIZE OF SEPARATORS





PDI PLATE

PROCEPTOR NOMINAL TANK DIMENSIONS INCH [MM]

MODEL	VOLUME (US GAL)	GREASE CAPACITY (US GAL)	SOLIDS CAPACITY (US GAL)	PIPE SIZE (P)	INLET (A)	OUTLET (B)	BURIAL (C)	HEIGHT (D)	SKU
GMC 150 IAP	150	200	48	4	33	32	8	45	102N0000
GMC 150 IAP	150	200	48	6	33	32	8	45	102N0100

NOTES:

1. IF 6" PIPING IS ORDERED, INSTALLER IS RESPONSIBLE FOR INSTALLING THE PROVIDED 4" PVC FLOW CONTROL

MANUFACTURER: ZURN GREEN TURTLE

PROCEPTOR MODEL NUMBER: GMC 150 IAP

STANDARDS: PDI G-101, ASME A112.14.3 & CSA B481.1

LIQUID CAPACITY (WORKING VOLUME): 150 US GAL

RATED FLOW: 100 GPM

PRODUCT TYPE: TYPE A RATING

ASME EFFICIENCY AT THE RATED CAPACITY: 97.1%

TESTED GREASE CAPACITY: 200 LBS

NOMINAL INLET SIZE: 4" (100 mm)

EXTERNAL FLOW CONTROL REQUIRED: SKU 4704

ACCESS COVER LOAD: S (CSA) & H20 (OTHERS)

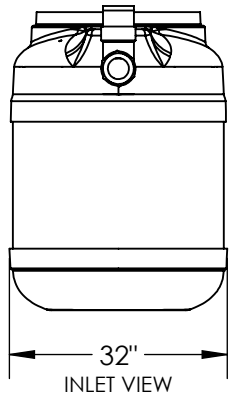
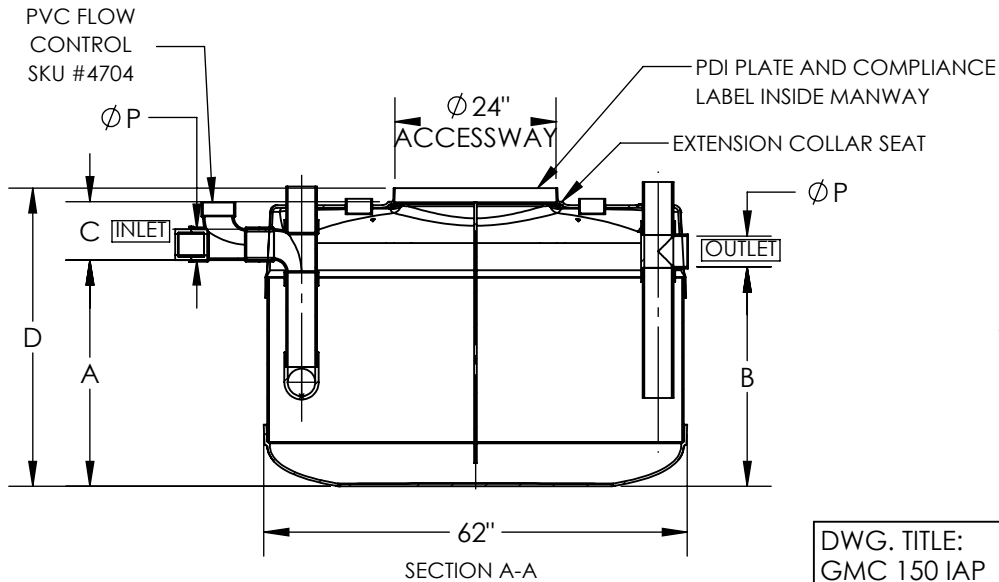
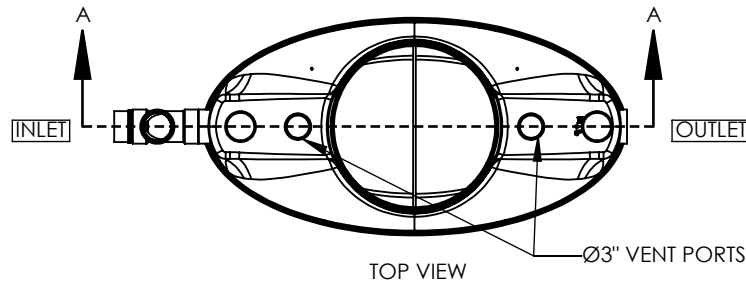

MONTH/YEAR OF MANUFACTURE:

IAP & CSA COMPLIANCE LABEL



COVERS WILL CARRY A LABEL SHOWING: :
ACCESS COVER LOAD: S (CSA)
TEMPERATURE: -34° C TO 71° C

MUST BE INSTALLED WITH FLOW CONTROL DEVICE SUPPLIED WITH EACH UNIT

DWG. TITLE: GMC 150 IAP		 	
PROJECT:			
DATE:			
SIZE A	DRAWING NOT TO SCALE	DWG #: 20-5390-S	REV. 2