



# Z1700

## INSTALLATION INSTRUCTIONS FOR SHOKTROL WATER HAMMER ARRESTOR

Design and Dimensional Data (inches and [ mm ]) are Subject to Manufacturing Tolerances and Change Without Notice

Zurn SHOKTROLS provide complete protection against water hammer in common pipe diameters for varying pipe lengths wherever flow velocity is subject to sudden change - in quick closing, solenoid-actuated valves used with lavatories and sinks, dishwashers, and residential automatic washers; in improperly adjusted water closet flush valves; in pumping systems, and in drinking fountains or similar installations where water flow is valved for intermittent operation.

Each SHOKTROL has its shock-absorbing air cushion hermetically sealed within the unit. Consequently, there is no loss of air from the SHOKTROL due to leakage past worn elastomeric sealing surfaces nor due to permeation through elastomeric features. In addition, the SHOKTROL's Type 304 (18-8) stainless steel construction makes it virtually immune to attack and degradation by high levels of chloramine and other common waterborne chemicals which quickly degrade elastomeric components.

Approved by:



**Zurn SHOKTROLS should always be installed in an upright position on a horizontal run of piping.**

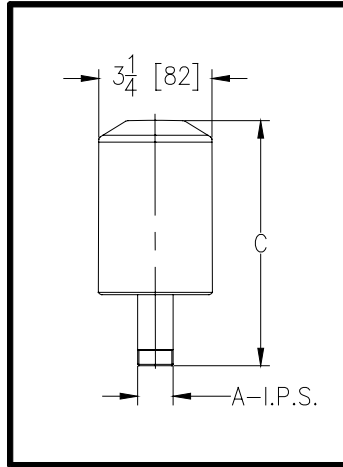

Size	Dimensions in Inches [mm]		Approx. Wt. Lbs. [kg]
	A	C	
100	3/4 [19]	3-1/4 [82]	15/16 [.425]
200	1 [25]	4-1/16 [103]	1-5/32 [.525]
300	1 [25]	4-3/8 [111]	1-5/16 [.60]
400	1 [25]	5-1/4 [133]	1-9/16 [.70]
500	1 [25]	7-1/32 [178]	2-3/16 [1]
600	1 [25]	7-1/32 [178]	2-3/16 [1]

**Pressure and Temperature Requirements:**

Max. Working Pressure: 125 psi  
 Max. Static Pressure: 250 psi  
 Max. Temperature: 300 °F

**SIZING AND LOCATION:**

When a unit of equipment is located at the remote end of a long run of piping, the Zurn SHOKTROL should be placed as close to the point of valve closure as possible. At this location, the SHOKTROL will control any developed energy and prevent shock waves from surging through the piping system (Illus. 1). Properly sized SHOKTROLS should be selected for such installations using Tables 1-A and 1-B below.

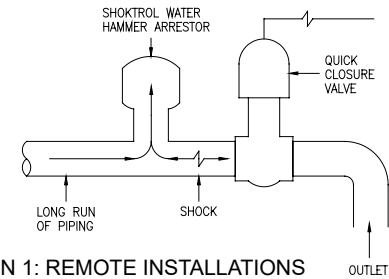

ILLUSTRATION 1: REMOTE INSTALLATIONS

**Table I-A. For Pressure Up To 65 spig**

Length of Pipe	Z1700 Series Zurn Shoktrol Water Hammer Arrestors Nominal Pipe Diameters					
	1/2"	3/4"	1"	1-1/4"	1-1/2"	2"
25	One #100	One #100	One #200	One #300	One #400	One #500
50	One #100	One #200	One #300	One #400	One #500	One #600
75	One #200	One #300	One #400	One #100 & One #500	One #600	One #500 & One #600
100	One #300	One #400	One #500	One #600	One #300 & One #600	Two #600
125'	One #300	One #400	One #600	One #100 & One #600	One #500 & One #600	One #500 & Two #600
150	One #400	One #500	One #600	One #400 & One #600	Two #600	Three #600

For further sizing information, see "Plumbing & Drainage Institute Standard WH-201."

**Table I-B. For Pressure 65 psig to 85 psig**

Length of Pipe	Z1700 Series Zurn Shoktrol Water Hammer Arrestors Nominal Pipe Diameters					
	1/2"	3/4"	1"	1-1/4"	1-1/2"	2"
25	One #200	One #200	One #300	One #400	One #500	One #600
50	One #200	One #300	One #400	One #500	One #600	One #300 & One #600
75	One #300	One #400	One #500	One #600	One #300 & One #600	Two #600
100	One #400	One #500	One #600	One #300 & One #600	One #500 & One #600	One #500 & Two #600
125'	One #400	One #500	One #300 & One #600	One #400 & One #600	Two #600	One #200 & Three #600
150	One #500	One #600	One #300 & One #600	Two #600	One #400 & Two #600	Four #600

For further sizing information, see "Plumbing & Drainage Institute Standard WH-201."

**⚠ WARNING:** Cancer and Reproductive Harm - [www.P65Warnings.ca.gov](http://www.P65Warnings.ca.gov)

**⚠ ADVERTENCIA:** Cáncer y daño reproductivo - [www.P65Warnings.ca.gov](http://www.P65Warnings.ca.gov)

**⚠ AVERTISSEMENT:** Cancer et effets néfastes sur la reproduction - [www.P65Warnings.ca.gov](http://www.P65Warnings.ca.gov)

Zurn Industries, LLC | Specification Drainage Operation  
 1801 Pittsburgh Avenue, Erie, PA 16502, Ph. 855.663.9876

In Canada | Zurn Industries Limited  
 7900 Goreway Drive, Unit 10, Brampton, Ontario L6T 5W6, Ph. 877.892.5216

[www.zurn.com](http://www.zurn.com)

Rev. E  
 Date: 08/28/23  
 C.N. No. 145154  
 Patent: Zurn.com/patents  
 Form # WH1



# Z1700

## INSTALLATION INSTRUCTIONS FOR SHOKTROL WATER HAMMER ARRESTOR

Design and Dimensional Data (inches and [ mm ]) are Subject to Manufacturing Tolerances and Change Without Notice

In an effort to arrive at a uniform method of sizing water hammer arrestors, members of the Plumbing and Drainage Institute sponsored a comprehensive testing program which lasted four years. As a result, there is now an industry-wide standard, P.D.I.-WH201 and the all-stainless-steel Zurn SHOKTROL conforms with every aspect of this newly-available information.

### HOW TO PROPERLY LOCATE ZURN SHOKTROLS

**Multiple Fixture-Branch Line Less Than 20' Long-(Illus. 2).** The preferred location for a Zurn SHOKTROL is at the end of the branch line between the last two fixtures served when the branch line does not exceed 20' in length, from the start of the horizontal branch line to the last fixture supply on the line (Use Tables II & III Below).

**Multiple Fixtures-Branch Line More Than 20' Long-(Illus. 3).** On branch lines over 20' in length, use two SHOKTROLS whose capacities total the requirements of the branch. Locate one unit between the last and next to last fixture and the other unit approximately midway between the fixtures. (Use Tables II & III Below).

**Multiple Fixtures-Extremely Long Branch Line-(Illus. 4).** In unusual instances where a very long branch line is involved, the water supply is generally fed to some midpoint or other location on the branch line. (Use Tables II & III Below).

**Illustration 2. Example of P.D.I. Rule 1**

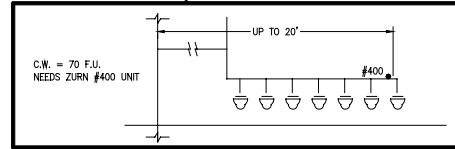

**Illustration 3. Example of P.D.I. Rule 2**

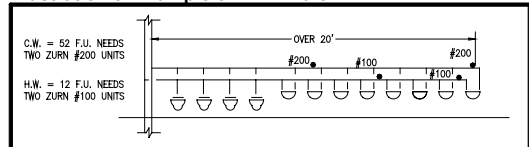

**Illustration 4. Example of P.D.I. Rule 1 and Rule 2**

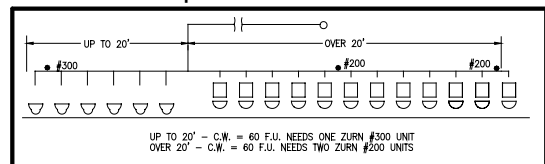

Standard P.D.I.-WH201 bases its sizing data upon the well-known fixture-unit formula. Since most engineers and specifiers utilize fixture-units in their daily calculations, it was appropriate to employ this method for quick, concise water hammer arrestor sizing.

Using Table II (below), determine the "weight in fixture-units" for cold and hot water branch lines serving a group of fixtures, either for public or private installations. When the "weight in" has been established, the data is then applied to the selection Table III.

Using the "weight in fixture-units" obtained from Table II, select the properly-sized SHOKTROL from Table III. If the water pressure in the line exceeds 65 PSIG, select the next larger size SHOKTROL. If the fixture-unit contains "1/2" fraction, "round it up" to the next larger or whole number. (Example: If total is 11-1/2 fixture units, change it to 12 fixture-units).

**Example 1**

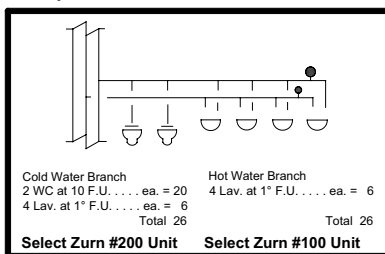

**Example 2**

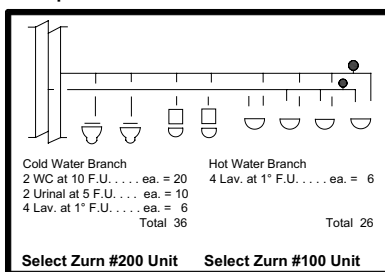

**Table II**

Fixture	Type of Supply Control	Weight in Fixture-Units					
		Public			Private		
		Total	C.W.	H.W.	Total	C.W.	H.W.
Water Closet	Flush Valve	10	10	-	6	6	-
Water Closet	Flush Tank	5	5	-	3	3	-
Pedestal Urinal	Flush Valve	10	10	-	-	-	-
Stall or Wall Urinal	Flush Valve	5	5	-	-	-	-
Stall or Wall Urinal	Flush Tank	3	3	-	-	-	-
Lavatory	Faucet	2	1-1/2	1-1/2	1	1	1
Bathtub	Faucet	4	2	3	2	1-1/2	1-1/2
Shower Head	Mixing Valve	4	2	3	2	1	2
Bathroom Group Closet	Flush Valve	-	-	-	8	8	3
Bathroom Group Closet	Flush Valve	-	-	-	6	6	3
Separate Shower	Mixing Valve	-	-	-	2	1	2
Service Sink	Faucet	3	3	3	-	-	-
Laundry Tubs (1-3)	Faucet	-	-	-	3	3	3
Combination Fixture	Faucet	-	-	-	3	3	3

**Table III**

Zurn Shoktrol Size Z1700 Series	#100	#200	#300	#400	#500	#600
P.D.I. Units	A	B	C	D	E	F
Fixture-Units	1-11	12-32	33-60	61-113	114-154	155-330

**⚠ WARNING:** Cancer and Reproductive Harm - [www.P65Warnings.ca.gov](http://www.P65Warnings.ca.gov)

**⚠ ADVERTENCIA:** Cáncer y daño reproductivo - [www.P65Warnings.ca.gov](http://www.P65Warnings.ca.gov)

**⚠ AVERTISSEMENT:** Cancer et effets néfastes sur la reproduction - [www.P65Warnings.ca.gov](http://www.P65Warnings.ca.gov)

Zurn Industries, LLC | Specification Drainage Operation  
1801 Pittsburgh Avenue, Erie, PA 16502, Ph. 855.663.9876

In Canada | Zurn Industries Limited  
7900 Goreway Drive, Unit 10, Brampton, Ontario L6T 5W6, Ph. 877.892.5216

[www.zurn.com](http://www.zurn.com)

Rev. E  
Date: 08/28/23  
C.N. No. 145154  
Patent: Zurn.com/patents  
Form # WH1