

ZEMS6140AV

Hardwired Automatic Sensor Valve for Water Closets

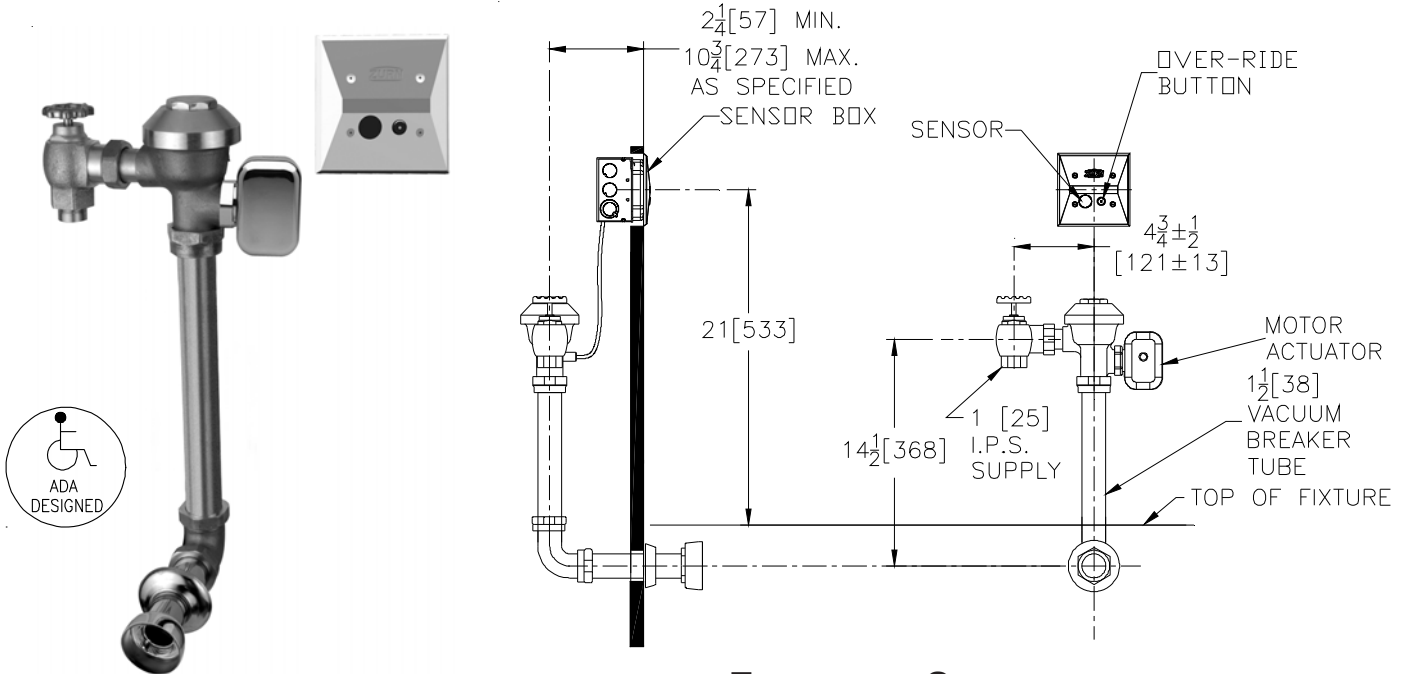

Flow Options

- WS1 1.6 gpf Low Consumption Flush
- FF 4.5 gpf Full Flush
- 3.5 gpf

Accessories

- _____ Other

Power Supply Choices (Sold Separately)

- ACA-BA 6VDC Plug-in Power Converter (Up to 6 valves)
- HW6 Hardwired Power Converter (Up to 8 Valves)
- MJ Mini Junction Box

Architectural/Engineering Approval

The information contained in this document is subject to change without notice.
Please contact Zurn for most up to date information.

NOTE: MUST USE EITHER ZURN P6000-HW6 HARDWIRE POWER CONVERTER OR ZURN P6900-ACA-BA PLUG-IN POWER CONVERTER TO ENSURE PROPER OPERATION. USING A POWER CONVERTER OTHER THAN ZURN MAY RESULT IN OPERATION MALFUNCTION OR UNIT FAILURE.

ZURN INDUSTRIES, LLC. ♦ COMMERCIAL BRASS OPERATION
5900 ELWIN BUCHANAN DRIVE ♦ SANFORD NC 27330
Phone: 1-800-997-3876 ♦ Fax: 919-775-3541
www.zurn.com
In Canada: ZURN INDUSTRIES LIMITED
3544 Nashua Drive ♦ Mississauga, Ontario L4V1L2
Phone: 905-405-8272 Fax: 905-405-1292

ENGINEERING SPECIFICATIONS

Concealed, quiet diaphragm-type, rough brass flushometer valve.

- Zurn's AquaVantage® TPE diaphragm
 - Clog Resistant Triple filtered by-pass
 - Chloramine resistant
 - Dual seal
- Proprietary DR resistant low lead brass alloy
- Actuator
 - ZEMS 6 VDC Motorized Actuator
- Automatic Sensor
 - Fully configurable sensor range adjustment
 - Manual push button override
 - 48 or 168 hour trap seal flush
 - Capacitive sensing push button override
- Control Stop
 - Internal siphon-guard protection
 - Sweat solder kit
- Vacuum Breaker
 - High back pressure
 - One piece hex coupling nut
- Internal seals
 - Chloramine resistant
- Adjustable tailpiece
- Spud coupling and flange for back spud connection