

Engineering Specifications: Zurn AquaSpec® Z843F4

Polished chrome-plated cast brass 8" [203mm] sink faucet with quarter turn ceramic disc cartridges, 3/8" [10mm] short swivel inlets providing adjustable centers from 7-1/4" [184mm] to 8-3/4" [222mm], integral service stops and a 6" [152mm] cast brass swing spout with a 2.2 GPM [8.3 L] pressure compensating aerator (complying with ANSI A112.18.1 Standard for flow). Unit is furnished with 4" [102mm] vandal-resistant color-coded metal wrist blade handles.

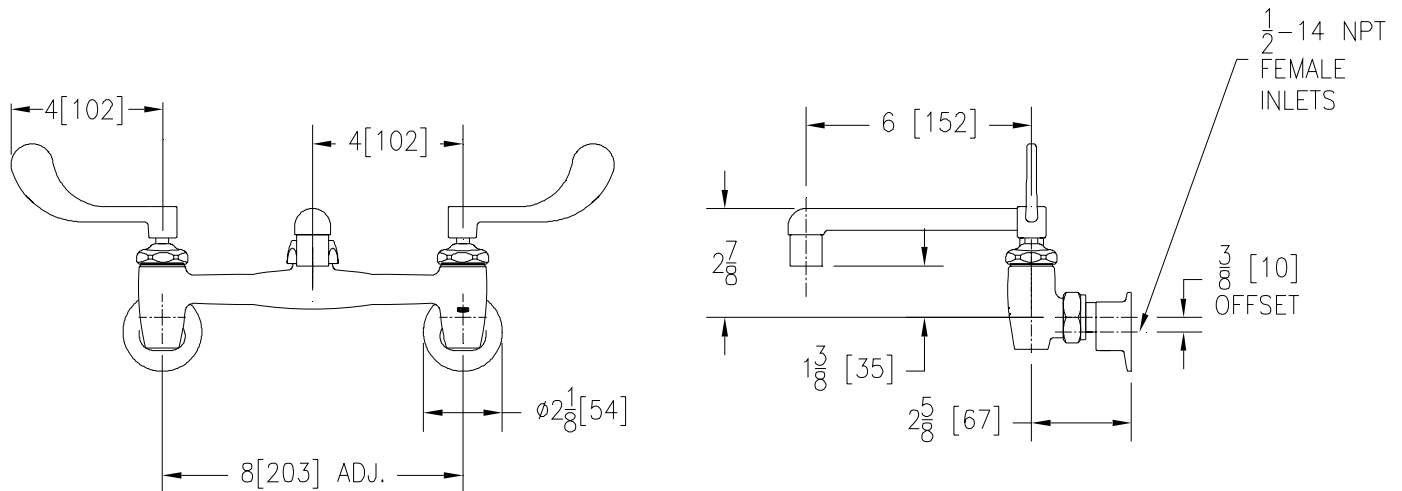

Note: All dimensions are for reference only. Do not use for pre-plumbing

OPTIONAL ACCESSORIES

Suffix	Description
___-CS	Check Stops
___-HCT	Hot/Cold Text Indexes
___-LSI	2-1/2" [64mm] Long Swivel Inlets
___-RC	Rough Chrome Plated
___-2F	2.2 GPM [8.3 L] Vandal-Resistant Pressure Compensating Female Aerator
___-3F	0.5 GPM [1.9 L] Vandal-Resistant Pressure Compensating Female Aerator
___-4F	2.2 GPM [8.3 L] Vandal-Resistant Pressure Compensating Female Laminar Flow
___-6P	Master Carton (Qty. 6)
___-7F	1.0 GPM [3.8 L] Pressure Compensating Female Spray Outlet
___-11F	Single Screen Outlet
___-16F	1.0 GPM [3.8 L] Vandal Resistant Pressure Compensating Female Spray Outlet
___-17F	1.5 GPM [5.7 L] Vandal Resistant Pressure Compensating Female Aerator
___-18F	1.5 GPM [5.7 L] Vandal Resistant Pressure Compensating Female Laminar Flow

ZURN INDUSTRIES, INC. ♦ COMMERCIAL BRASS OPERATION ♦ 2640 SOUTH WORK STREET ♦ FALCONER NY 14733

Phone: 1-716-665-1132 ♦ Fax: 1-716-665-1135 ♦ World Wide Web: www.zurn.com

In Canada: ZURN INDUSTRIES LIMITED ♦ 3544 Nashua Drive ♦ Mississauga, Ontario L4V1L2 ♦ Phone: 905/405-8272 Fax: 905/405-1292