



# ROUND GRATE/COVER REPLACEMENTS

## Notes:

1. Casting number indicates a part number & is generally located on the underside of each cleanout cover.
2. Order number used for all ordering purposes.
3. Standard Cover Material is Cast Iron. Order numbers may vary for different materials.
4. Contact your local sales representative for all order inquiries & assistance on material availability as these may vary from part to part.

## FLOOR DRAINS

Z400B, Z415B							
Item No.	Strainer Designation	Diameter 'A'	Rim Thickness 'B'	R.B.C. 'C'	Open Area. Sq. In.	Ordering No.	Casting No.
1	-	4-7/8"	1/8"	2-1/4"	6	PB400-5B-STR-4-7/8	46243-13
2	-5B	5"	1/8"	2-1/4"	6	PB400-5B-STR	46243-1
3	-6B	6"	1/8"	2-3/4"	8	PB400-6B-STR	46234-1
4	-7B	6-11/16"	5/32"	3-1/8"	12	PB400-7B-STR	46246-1
5	-8B	7-11/16"	5/32"	3-5/8"	20	PB400-8B-STR	46272-1
6	-10B	9-1/16"	1/4"	4-1/8"	22	PB400-10B-STR-USA	47118-1

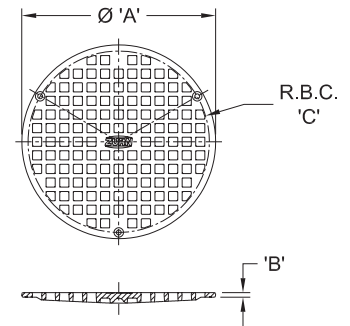

Z400C, Z415C							
Item No.	Strainer Designation	Diameter 'A'	Rim Thickness 'B'	R.B.C. 'C'	Open Area. Sq. In.	Ordering No.	Casting No.
7	-5C	5"	1/8"	2-1/4"	4.6	PB400-5C-STR-USA	25691-1
8	-6C	6"	1/8"	2-3/4"	7.6	PB400-6C-STR	25692-1
9	-7C	6-47/64"	5/32"	3-1/8"	11.4	PB400-7C-STR-USA	25693-1
10	-8C	7-47/64"	5/32"	3-5/8"	11.4	PB400-8C-STR-USA	25695-1

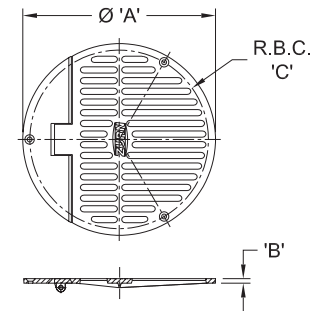

Z400D, Z415D							
Item No.	Cover Designation	Diameter 'A'	Rim Thickness 'B'	R.B.C. 'C'	Open Area. Sq. In.	Ordering No.	Casting No.
11	-5C	5"	1/8"	2-1/4"	-	PB400-5C-COVER-USA	25691-2
12	-6C	6"	1/8"	2-3/4"	-	PB400-6D-COVER-USA	25692-2
13	-7C	6-47/64"	5/32"	3-1/8"	-	PB400-7D-COVER	25694-1
14	-8C	7-47/64"	5/32"	3-5/8"	-	PB400-8D-COVER-USA	25696-1

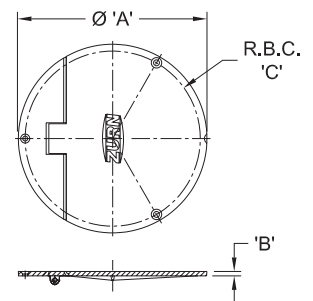

**⚠ WARNING:** Cancer and Reproductive Harm - [www.P65Warnings.ca.gov](http://www.P65Warnings.ca.gov)  
**⚠ ADVERTENCIA:** Cáncer y daño reproductivo - [www.P65Warnings.ca.gov](http://www.P65Warnings.ca.gov)  
**⚠ AVERTISSEMENT:** Cancer et effets néfastes sur la reproduction - [www.P65Warnings.ca.gov](http://www.P65Warnings.ca.gov)

Zurn Industries, LLC | Specification Drainage Operation  
1801 Pittsburgh Avenue, Erie, PA 16502, Ph. 855.663.9876

In Canada | Zurn Industries Limited  
7900 Goreway Drive, Unit 10, Brampton, Ontario L6T 5W6, Ph. 877.892.5216

[www.zurn.com](http://www.zurn.com)

Rev. -  
 Date: 10/13/2021  
 C.N. No. 144086  
 Prod. | Dwg. No. FD137



# ROUND GRATE/COVER REPLACEMENTS

Z400 & Z415 'TYPE I' & 'TYPE N'							
Item No.	Strainer Designation	Diameter 'A'	Rim Thickness 'B'	R.B.C. 'C'	Open Area. Sq. In.	Ordering No.	Casting No.
15	-7I	6-7/8"	3/16"	3-1/4"	13	PB400-7I-STR-USA	20693-1
16	-9I	8-1/2"	3/16"	3-3/4"	23	PB400-9I-N-STR-USA	20651-1

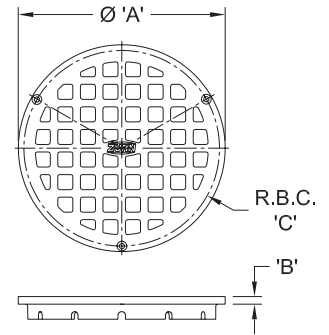

Z742, Z566							
Item No.	Strainer Designation	Diameter 'A'	Rim Thickness 'B'	R.B.C. 'C'	Open Area. Sq. In.	Ordering No.	Casting No.
17	2	7"	1/4"	3"	15	P742-GRATE-2	38261-1
18	3	9-3/8"	1/2"	4-3/16"	19	P742-GRATE-3-USA	18694-1
19	4	10-3/4"	1/2"	4-7/8"	40	P742-GRATE-4-USA	38600-1

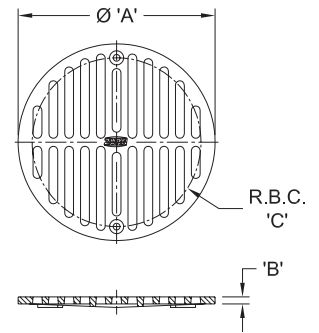

ZS400BS, ZS415BS, Z1726							
Item No.	Strainer Designation	Diameter 'A'	Rim Thickness 'B'	R.B.C. 'C'	Open Area. Sq. In.	Ordering No.	Casting No.
20	Z1726-RD5	5"	1/8"	2-1/4"	7	PS400-B-RD5-STR	66662-1
21	Z1726-RD6	6"	1/8"	2-3/4"	11	PS400-B-RD6-STR-USA	66731-1
22	Z1726-RD7	6-11/16"	5/32"	3-1/8"	15	PS400-7BS-STR	66732-1
23	Z1726-RD8	7-11/16"	5/32"	3-5/8"	20	PS400-8B-STR-USA	66733-1
24	Z1726-RD10	9-1/16"	1/4"	4-1/8"	27	PS400-10B-STR	66734-1

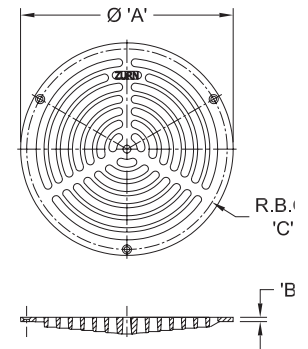

⚠ **WARNING:** Cancer and Reproductive Harm - [www.P65Warnings.ca.gov](http://www.P65Warnings.ca.gov)  
 ⚠ **ADVERTENCIA:** Cáncer y daño reproductivo - [www.P65Warnings.ca.gov](http://www.P65Warnings.ca.gov)  
 ⚠ **AVERTISSEMENT:** Cancer et effets néfastes sur la reproduction - [www.P65Warnings.ca.gov](http://www.P65Warnings.ca.gov)

Zurn Industries, LLC | Specification Drainage Operation  
1801 Pittsburgh Avenue, Erie, PA 16502, Ph. 855.663.9876

In Canada | Zurn Industries Limited  
7900 Goreway Drive, Unit 10, Brampton, Ontario L6T 5W6, Ph. 877.892.5216

[www.zurn.com](http://www.zurn.com)

Rev. -  
 Date: 10/13/2021  
 C.N. No. 144086  
 Prod. | Dwg. No. FD137



# ROUND GRATE/COVER REPLACEMENTS

Z300, Z310						
Item No.	Diameter 'A'	Rim Thickness 'B'	R.B.C. 'C'	Open Area. Sq. In.	Ordering No.	Casting No.
25	8"	3/16"	-	5.9	PN300-HINGED-GRATE	46169-1

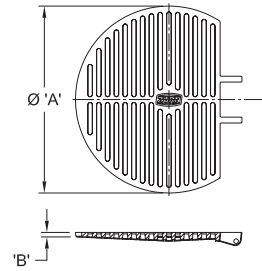

Z300-FG, Z310-FG						
Item No.	Diameter 'A'	Rim Thickness 'B'	R.B.C. 'C'	Open Area. Sq. In.	Ordering No.	Casting No.
26	7-15/16"	3/16"	-	15.4	PN300-FG-GRATE-USA	25035-3

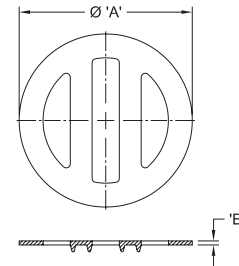

Z300-IG, Z310-IG						
Item No.	Diameter 'A'	Rim Thickness 'B'	R.B.C. 'C'	Open Area. Sq. In.	Ordering No.	Casting No.
27	11	3/16"	5-3/16"	15.4	PN300-IG-GRATE-USA	25035-1

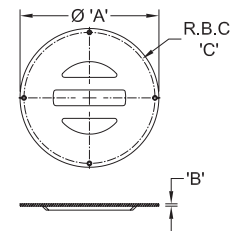

Z300-SC						
Item No.	Diameter 'A'	Rim Thickness 'B'	R.B.C. 'C'	Open Area. Sq. In.	Ordering No.	Casting No.
28	11	3/16"	5-3/16"	-	PB300-SC-USA	25035-4

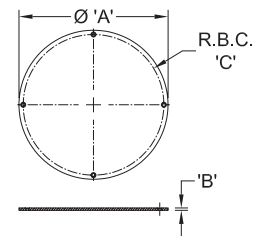

Z300-ST, Z310-ST						
Item No.	Diameter 'A'	Rim Thickness 'B'	R.B.C. 'C'	Open Area. Sq. In.	Ordering No.	Casting No.
29	8"	3/16"	2-13/16"	-	PN300-ST-COVER-USA	46169-2

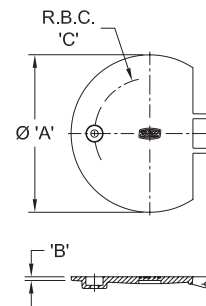

⚠ **WARNING:** Cancer and Reproductive Harm - [www.P65Warnings.ca.gov](http://www.P65Warnings.ca.gov)  
 ⚠ **ADVERTENCIA:** Cáncer y daño reproductivo - [www.P65Warnings.ca.gov](http://www.P65Warnings.ca.gov)  
 ⚠ **AVERTISSEMENT:** Cancer et effets néfastes sur la reproduction - [www.P65Warnings.ca.gov](http://www.P65Warnings.ca.gov)

Zurn Industries, LLC | Specification Drainage Operation  
 1801 Pittsburgh Avenue, Erie, PA 16502, Ph. 855.663.9876

In Canada | Zurn Industries Limited  
 7900 Goreway Drive, Unit 10, Brampton, Ontario L6T 5W6, Ph. 877.892.5216

[www.zurn.com](http://www.zurn.com)

Rev. -  
 Date: 10/13/2021  
 C.N. No. 144086  
 Prod. | Dwg. No. FD137



# ROUND GRATE/COVER REPLACEMENTS

Z319						
Item No.	Diameter 'A'	Rim Thickness 'B'	R.B.C. 'C'	Open Area. Sq. In.	Ordering No.	Casting No.
30	24"	3/8"	11-1/2"	232	PN319-GRATE-USA	7895-1

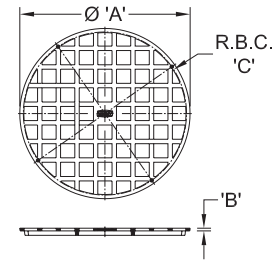

Z320						
Item No.	Diameter 'A'	Rim Thickness 'B'	R.B.C. 'C'	Open Area. Sq. In.	Ordering No.	Casting No.
31	5-3/4"	7/32"	-	7.5	079520012	7952-1

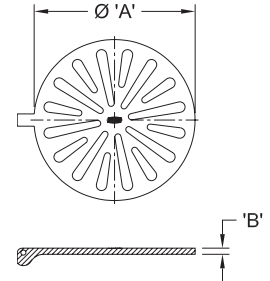

Z355						
Item No.	Diameter 'A'	Rim Thickness 'B'	R.B.C. 'C'	Open Area. Sq. In.	Ordering No.	Casting No.
32	3-3/16"	1/8"	1-13/32"	2.8	PN355-GRATE-USA	7354-1

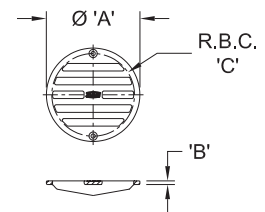

Z400 'TYPE M'						
Item No.	Diameter 'A'	Rim Thickness 'B'	R.B.C. 'C'	Open Area. Sq. In.	Ordering No.	Casting No.
33	3-1/2"	1/8"	-	4	676270012	67627-1

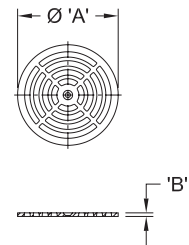

Z503, Z1737						
Item No.	Diameter 'A'	Rim Thickness 'B'	R.B.C. 'C'	Open Area. Sq. In.	Ordering No.	Casting No.
34	14-1/4"	3/4"	6-3/4"	53	P503-GRATE	1519-1

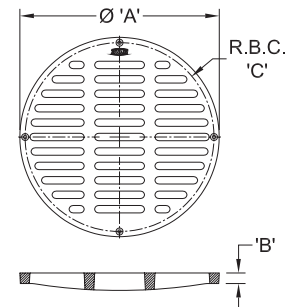

**⚠ WARNING:** Cancer and Reproductive Harm - [www.P65Warnings.ca.gov](http://www.P65Warnings.ca.gov)  
**⚠ ADVERTENCIA:** Cáncer y daño reproductivo - [www.P65Warnings.ca.gov](http://www.P65Warnings.ca.gov)  
**⚠ AVERTISSEMENT:** Cancer et effets néfastes sur la reproduction - [www.P65Warnings.ca.gov](http://www.P65Warnings.ca.gov)

Zurn Industries, LLC | Specification Drainage Operation  
1801 Pittsburgh Avenue, Erie, PA 16502, Ph. 855.663.9876

In Canada | Zurn Industries Limited  
7900 Goreway Drive, Unit 10, Brampton, Ontario L6T 5W6, Ph. 877.892.5216

[www.zurn.com](http://www.zurn.com)

Rev. -  
 Date: 10/13/2021  
 C.N. No. 144086  
 Prod. | Dwg. No. FD137



# ROUND GRATE/COVER REPLACEMENTS

Z505, Z509, Z512, Z534						
Item No.	Diameter 'A'	Rim Thickness 'B'	R.B.C. 'C'	Open Area. Sq. In.	Ordering No.	Casting No.
35	11-3/16"	1-1/4"	4-13/16"	33	P509-DG-GRATE	50453-16

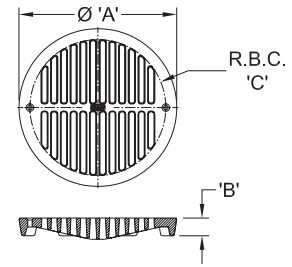

Z505, Z509, Z534, -HP Heel Proof Grate						
Item No.	Diameter 'A'	Rim Thickness 'B'	R.B.C. 'C'	Open Area. Sq. In.	Ordering No.	Casting No.
36	11-3/16"	1-1/4"	4-13/16"	29	P504-HP-GRATE	58750-9

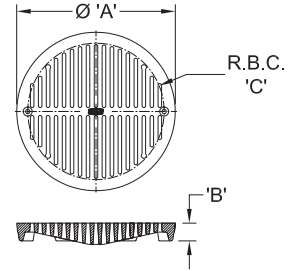

Z505, Z509, Z512, -SC Solid Cover						
Item No.	Diameter 'A'	Rim Thickness 'B'	R.B.C. 'C'	Open Area. Sq. In.	Ordering No.	Casting No.
37	11-3/16"	5/8"	-	-	P541-SOLIDCOVER-USA	83019-1

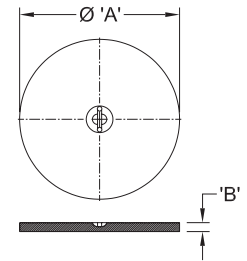

Z507						
Item No.	Diameter 'A'	Rim Thickness 'B'	R.B.C. 'C'	Open Area. Sq. In.	Ordering No.	Casting No.
38	6-3/8"	1-3/4"	2 7/8"	9	P507-GRATE-USA	4177-1

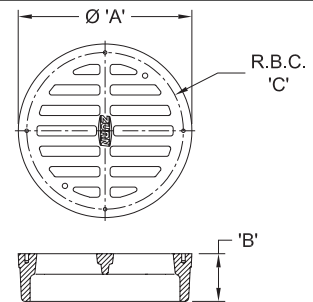

Z508, Z511, Z520, Z627						
Item No.	Diameter 'A'	Rim Thickness 'B'	R.B.C. 'C'	Open Area. Sq. In.	Ordering No.	Casting No.
39	8-1/16"	1-3/4"	-	15	P508-GRATE	56965-1

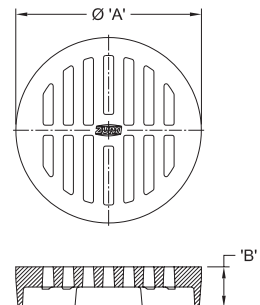

**⚠ WARNING:** Cancer and Reproductive Harm - [www.P65Warnings.ca.gov](http://www.P65Warnings.ca.gov)  
**⚠ ADVERTENCIA:** Cáncer y daño reproductivo - [www.P65Warnings.ca.gov](http://www.P65Warnings.ca.gov)  
**⚠ AVERTISSEMENT:** Cancer et effets néfastes sur la reproduction - [www.P65Warnings.ca.gov](http://www.P65Warnings.ca.gov)

Zurn Industries, LLC | Specification Drainage Operation  
1801 Pittsburgh Avenue, Erie, PA 16502, Ph. 855.663.9876

In Canada | Zurn Industries Limited  
7900 Goreway Drive, Unit 10, Brampton, Ontario L6T 5W6, Ph. 877.892.5216

[www.zurn.com](http://www.zurn.com)

Rev. -  
 Date: 10/13/2021  
 C.N. No. 144086  
 Prod. | Dwg. No. FD137



# ROUND GRATE/COVER REPLACEMENTS

Z508, Z511, Z520, -HP Heel Proof Grate						
Item No.	Diameter 'A'	Rim Thickness 'B'	R.B.C. 'C'	Open Area. Sq. In.	Ordering No.	Casting No.
40	8-1/16"	1-3/4"	-	9	P508-HP-DG-GRATE-USA	56965-5

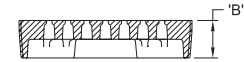
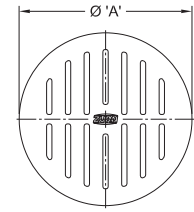

Z508, Z511, -SC Solid Cover						
Item No.	Diameter 'A'	Rim Thickness 'B'	R.B.C. 'C'	Open Area. Sq. In.	Ordering No.	Casting No.
41	8-1/16"	1-3/4"	3-7/16"	-	P1474-COVER	56966-2

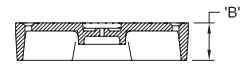
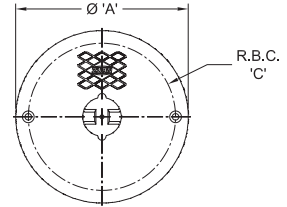

Z508, Z511, -SG Solid Gasketed Cover						
Item No.	Diameter 'A'	Rim Thickness 'B'	R.B.C. 'C'	Open Area. Sq. In.	Ordering No.	Casting No.
42	8-1/16"	1-3/4"	-	-	P679-COVER	56966-5

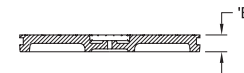
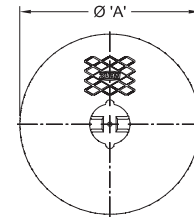

Z521						
Item No.	Diameter 'A'	Rim Thickness 'B'	R.B.C. 'C'	Open Area. Sq. In.	Ordering No.	Casting No.
43	11-3/8"	1-3/4"	5"	25	P521-DG-GRATE-USA	4190-1

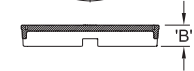
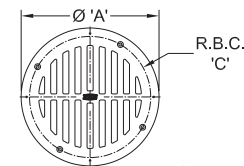

Z521-Y						
Item No.	Diameter 'A'	Rim Thickness 'B'	R.B.C. 'C'	Open Area. Sq. In.	Ordering No.	Casting No.
44	11-3/8"	1-1/8"	5"	25	P521-Y-GRATE-USA	4190-2

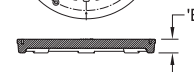
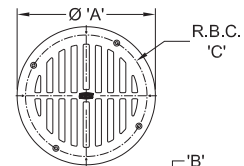

⚠ **WARNING:** Cancer and Reproductive Harm - [www.P65Warnings.ca.gov](http://www.P65Warnings.ca.gov)  
 ⚠ **ADVERTENCIA:** Cáncer y daño reproductivo - [www.P65Warnings.ca.gov](http://www.P65Warnings.ca.gov)  
 ⚠ **AVERTISSEMENT:** Cancer et effets néfastes sur la reproduction - [www.P65Warnings.ca.gov](http://www.P65Warnings.ca.gov)

Zurn Industries, LLC | Specification Drainage Operation  
1801 Pittsburgh Avenue, Erie, PA 16502, Ph. 855.663.9876

In Canada | Zurn Industries Limited  
7900 Goreway Drive, Unit 10, Brampton, Ontario L6T 5W6, Ph. 877.892.5216

[www.zurn.com](http://www.zurn.com)

Rev. -  
 Date: 10/13/2021  
 C.N. No. 144086  
 Prod. | Dwg. No. FD137



# ROUND GRATE/COVER REPLACEMENTS

## Z521, Z526, Z532, Z539, Z541

Item No.	Diameter 'A'	Rim Thickness 'B'	R.B.C. 'C'	Open Area. Sq. In.	Ordering No.	Casting No.
45	11-3/16"	5/8"	4-13/16"	33	P541-GRATE-USA	50453-1

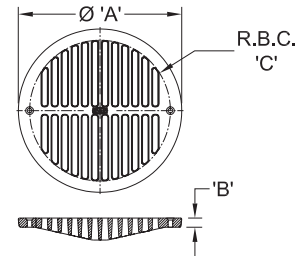

## Z526, Z532, Z539, Z541, -HP Heel Proof Grate

Item No.	Diameter 'A'	Rim Thickness 'B'	R.B.C. 'C'	Open Area. Sq. In.	Ordering No.	Casting No.
46	11-3/16"	5/8"	4-13/16"	29	P541-HP-GRATE	58750-1

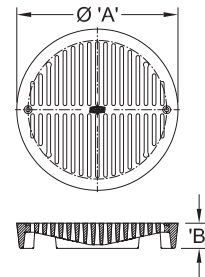

## Z541-H

Item No.	Diameter 'A'	Rim Thickness 'B'	R.B.C. 'C'	Open Area. Sq. In.	Ordering No.	Casting No.
47	11-3/16"	5/8"	4-13/16"	33	P541-H-GRATE-USA	57494-1

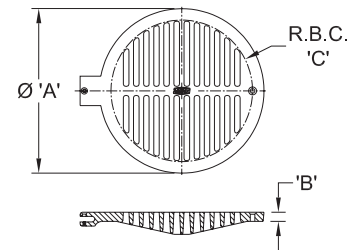

## Z541-TG

Item No.	Diameter 'A'	Rim Thickness 'B'	R.B.C. 'C'	Open Area. Sq. In.	Ordering No.	Casting No.
48	11-3/16"	2-1/16"	-	33	P541-TG-GRATE	50453-24

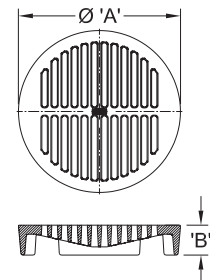

## Z541-WS

Item No.	Diameter 'A'	Rim Thickness 'B'	R.B.C. 'C'	Open Area. Sq. In.	Ordering No.	Casting No.
49	11-3/16"	5/8"	-	51	P541-WS-GRATE-USA	57495-1

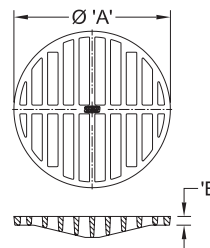

**⚠ WARNING:** Cancer and Reproductive Harm - [www.P65Warnings.ca.gov](http://www.P65Warnings.ca.gov)  
**⚠ ADVERTENCIA:** Cáncer y daño reproductivo - [www.P65Warnings.ca.gov](http://www.P65Warnings.ca.gov)  
**⚠ AVERTISSEMENT:** Cancer et effets néfastes sur la reproduction - [www.P65Warnings.ca.gov](http://www.P65Warnings.ca.gov)

Zurn Industries, LLC | Specification Drainage Operation  
1801 Pittsburgh Avenue, Erie, PA 16502, Ph. 855.663.9876

In Canada | Zurn Industries Limited  
7900 Goreway Drive, Unit 10, Brampton, Ontario L6T 5W6, Ph. 877.892.5216

[www.zurn.com](http://www.zurn.com)

Rev. -  
 Date: 10/13/2021  
 C.N. No. 144086  
 Prod. | Dwg. No. FD137



# ROUND GRATE/COVER REPLACEMENTS

Z533, Z540, Z550, Z551, Z624, Z1970						
Item No.	Diameter 'A'	Rim Thickness 'B'	R.B.C. 'C'	Open Area. Sq. In.	Ordering No.	Casting No.
50	8"	5/8"	3-3/4"	18	P550-GRATE	50570-6

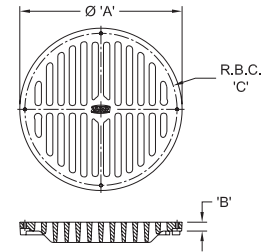

Z530						
Item No.	Diameter 'A'	Rim Thickness 'B'	R.B.C. 'C'	Open Area. Sq. In.	Ordering No.	Casting No.
51	8"	7/16"	3-3/4"	26	P551-Y-GRATE	50570-1

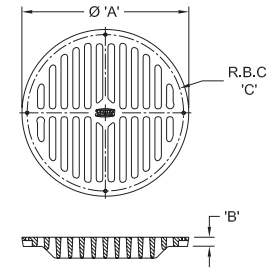

Z536						
Item No.	Diameter 'A'	Rim Thickness 'B'	R.B.C. 'C'	Open Area. Sq. In.	Ordering No.	Casting No.
52	14-1/4"	1-1/2"	6-3/4"	53	P536-GRATE	1519-4

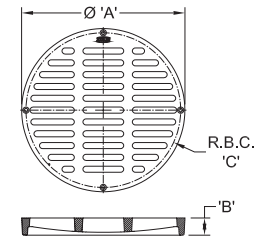

Z545						
Item No.	Diameter 'A'	Rim Thickness 'B'	R.B.C. 'C'	Open Area. Sq. In.	Ordering No.	Casting No.
53	14-1/8"	1-1/2"	6-3/8"	50	P545-GRATE	2219-4

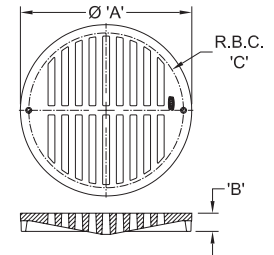

Z546						
Item No.	Diameter 'A'	Rim Thickness 'B'	R.B.C. 'C'	Open Area. Sq. In.	Ordering No.	Casting No.
54	19-7/8"	1"	9-5/8"	110	820670011	82067-1

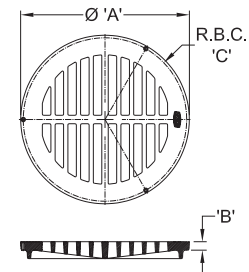

⚠ **WARNING:** Cancer and Reproductive Harm - [www.P65Warnings.ca.gov](http://www.P65Warnings.ca.gov)  
 ⚠ **ADVERTENCIA:** Cáncer y daño reproductivo - [www.P65Warnings.ca.gov](http://www.P65Warnings.ca.gov)  
 ⚠ **AVERTISSEMENT:** Cancer et effets néfastes sur la reproduction - [www.P65Warnings.ca.gov](http://www.P65Warnings.ca.gov)

Zurn Industries, LLC | Specification Drainage Operation  
1801 Pittsburgh Avenue, Erie, PA 16502, Ph. 855.663.9876

In Canada | Zurn Industries Limited  
7900 Goreway Drive, Unit 10, Brampton, Ontario L6T 5W6, Ph. 877.892.5216

[www.zurn.com](http://www.zurn.com)

Rev. -  
 Date: 10/13/2021  
 C.N. No. 144086  
 Prod. | Dwg. No. FD137





# ROUND GRATE/COVER REPLACEMENTS

Z547						
Item No.	Diameter 'A'	Rim Thickness 'B'	R.B.C. 'C'	Open Area. Sq. In.	Ordering No.	Casting No.
55	19-7/8"	1"	9-5/8"	112	P547-GRATE	82901-1

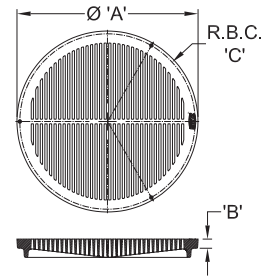

Z554						
Item No.	Diameter 'A'	Rim Thickness 'B'	R.B.C. 'C'	Open Area. Sq. In.	Ordering No.	Casting No.
56	6"	5/16"	2-23/32"	8	P554-GRATE-USA	56628-1

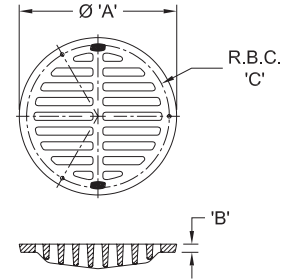

Z556						
Item No.	Diameter 'A'	Rim Thickness 'B'	R.B.C. 'C'	Open Area. Sq. In.	Ordering No.	Casting No.
57	6-3/4"	1-1/4"	3-3/32"	13	P556-GRATE	51351-1

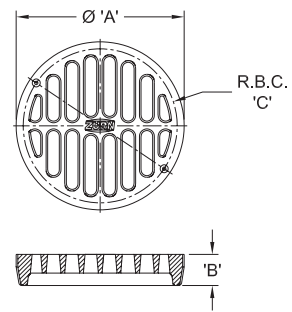

Z730						
Item No.	Diameter 'A'	Rim Thickness 'B'	R.B.C. 'C'	Open Area. Sq. In.	Ordering No.	Casting No.
58	8-1/4"	9/16"	-	24	P525-T-GRATE-USA	7549-1

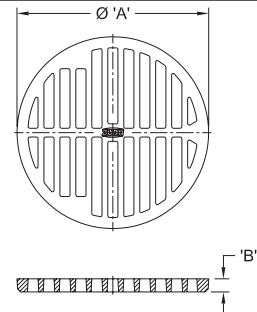

Z742-2SP						
Item No.	Diameter 'A'	Rim Thickness 'B'	R.B.C. 'C'	Open Area. Sq. In.	Ordering No.	Casting No.
59	7"	1/4"	3"	13	P742-GRATE-2	38261-1

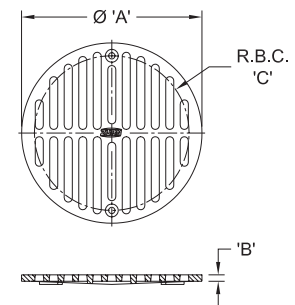

⚠ **WARNING:** Cancer and Reproductive Harm - [www.P65Warnings.ca.gov](http://www.P65Warnings.ca.gov)  
 ⚠ **ADVERTENCIA:** Cáncer y daño reproductivo - [www.P65Warnings.ca.gov](http://www.P65Warnings.ca.gov)  
 ⚠ **AVERTISSEMENT:** Cancer et effets néfastes sur la reproduction - [www.P65Warnings.ca.gov](http://www.P65Warnings.ca.gov)

Zurn Industries, LLC | Specification Drainage Operation  
1801 Pittsburgh Avenue, Erie, PA 16502, Ph. 855.663.9876

In Canada | Zurn Industries Limited  
7900 Goreway Drive, Unit 10, Brampton, Ontario L6T 5W6, Ph. 877.892.5216

[www.zurn.com](http://www.zurn.com)

Rev. -  
Date: 10/13/2021  
C.N. No. 144086  
Prod. | Dwg. No. FD137



# ROUND GRATE/COVER REPLACEMENTS

Z742-3SP						
Item No.	Diameter 'A'	Rim Thickness 'B'	R.B.C. 'C'	Open Area. Sq. In.	Ordering No.	Casting No.
60	9-3/8"	1/2"	4-3/8"	19	P742-GRATE-3-USA	18694-1

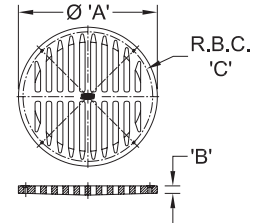

Z742-4SP						
Item No.	Diameter 'A'	Rim Thickness 'B'	R.B.C. 'C'	Open Area. Sq. In.	Ordering No.	Casting No.
61	10-3/4"	1/2"	4-7/8"	40	P742-GRATE-4-USA	38600-1

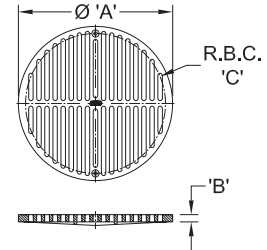

Z1730, Z1731						
Item No.	Diameter 'A'	Rim Thickness 'B'	R.B.C. 'C'	Open Area. Sq. In.	Ordering No.	Casting No.
62	8"	5/8"	-	21	P1730-GRATE	53861-1

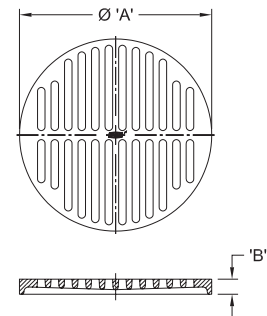

Z1732						
Item No.	Diameter 'A'	Rim Thickness 'B'	R.B.C. 'C'	Open Area. Sq. In.	Ordering No.	Casting No.
63	8-11/32"	1-1/2"	3-1/2"	14	P1732-GRATE	4101-4

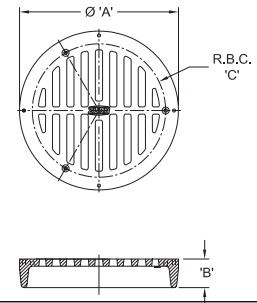

Z1732 -SC Solid Cover						
Item No.	Diameter 'A'	Rim Thickness 'B'	R.B.C. 'C'	Open Area. Sq. In.	Ordering No.	Casting No.
64	8-11/32"	1-1/2"	3-1/2"	-	P1732-COVER	4101-17

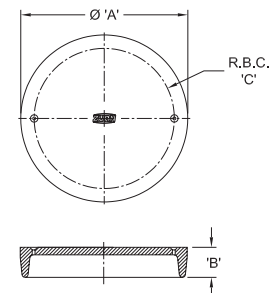

⚠ **WARNING:** Cancer and Reproductive Harm - [www.P65Warnings.ca.gov](http://www.P65Warnings.ca.gov)  
 ⚠ **ADVERTENCIA:** Cáncer y daño reproductivo - [www.P65Warnings.ca.gov](http://www.P65Warnings.ca.gov)  
 ⚠ **AVERTISSEMENT:** Cancer et effets néfastes sur la reproduction - [www.P65Warnings.ca.gov](http://www.P65Warnings.ca.gov)

Zurn Industries, LLC | Specification Drainage Operation  
1801 Pittsburgh Avenue, Erie, PA 16502, Ph. 855.663.9876

In Canada | Zurn Industries Limited  
7900 Goreway Drive, Unit 10, Brampton, Ontario L6T 5W6, Ph. 877.892.5216

[www.zurn.com](http://www.zurn.com)

Rev. -  
 Date: 10/13/2021  
 C.N. No. 144086  
 Prod. | Dwg. No. FD137



# ROUND GRATE/COVER REPLACEMENTS

## Z541, Z1735

Item No.	Diameter 'A'	Rim Thickness 'B'	R.B.C. 'C'	Open Area. Sq. In.	Ordering No.	Casting No.
65	11-1/4"	5/8"	5-7/32"	33	P1735-GRATE	1956-1

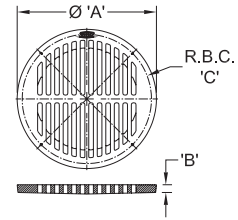

## Z1950 Full Grate

Item No.	Diameter 'A'	Rim Thickness 'B'	R.B.C. 'C'	Open Area. Sq. In.	Ordering No.	Casting No.
66	10-1/2"	1/2"	-	-	P1950-FULL-GRATE	50800-1

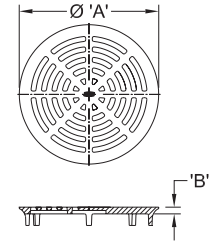

## Z1950 Half Grate

Item No.	Diameter 'A'	Rim Thickness 'B'	R.B.C. 'C'	Open Area. Sq. In.	Ordering No.	Casting No.
67	10-1/2"	1/2"	-	-	P1950-2-GRATE	50800-3

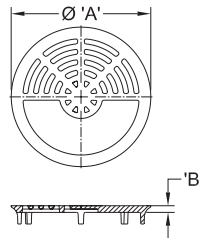

## Z1950 3/4 Grate

Item No.	Diameter 'A'	Rim Thickness 'B'	R.B.C. 'C'	Open Area. Sq. In.	Ordering No.	Casting No.
68	10-1/2"	1/2"	-	-	P1950-3-GRATE	50800-2

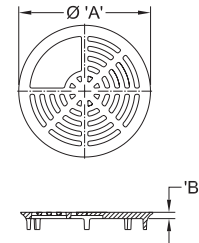

## Z1950 Full Grate with Center Opening

Item No.	Diameter 'A'	Rim Thickness 'B'	R.B.C. 'C'	Open Area. Sq. In.	Ordering No.	Casting No.
69	10-1/2"	1/2"	-	-	P1950-4-GRATE	50800-4

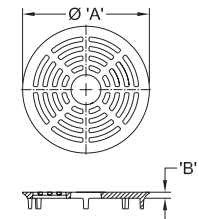

**⚠ WARNING:** Cancer and Reproductive Harm - [www.P65Warnings.ca.gov](http://www.P65Warnings.ca.gov)

**⚠ ADVERTENCIA:** Cáncer y daño reproductivo - [www.P65Warnings.ca.gov](http://www.P65Warnings.ca.gov)

**⚠ AVERTISSEMENT:** Cancer et effets néfastes sur la reproduction - [www.P65Warnings.ca.gov](http://www.P65Warnings.ca.gov)

Zurn Industries, LLC | Specification Drainage Operation  
1801 Pittsburgh Avenue, Erie, PA 16502, Ph. 855.663.9876

In Canada | Zurn Industries Limited  
7900 Goreway Drive, Unit 10, Brampton, Ontario L6T 5W6, Ph. 877.892.5216

[www.zurn.com](http://www.zurn.com)

Rev. -  
Date: 10/13/2021  
C.N. No. 144086  
Prod. | Dwg. No. FD137



# ROUND GRATE/COVER REPLACEMENTS

Z1950 Solid Cover						
Item No.	Diameter 'A'	Rim Thickness 'B'	R.B.C. 'C'	Open Area. Sq. In.	Ordering No.	Casting No.
70	10-1/2"	1/4"	-	-	P1950-15-COVER-USA	57639-1

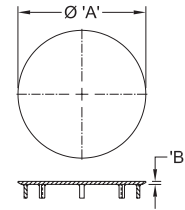

ZN1950 Full Grate						
Item No.	Diameter 'A'	Rim Thickness 'B'	R.B.C. 'C'	Open Area. Sq. In.	Ordering No.	Casting No.
71	10-27/32"	3/16"	5-5/32"	-	PN1950-GRATE	38144-2

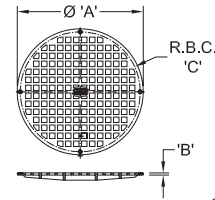

ZN1950 Half Grate						
Item No.	Diameter 'A'	Rim Thickness 'B'	R.B.C. 'C'	Open Area. Sq. In.	Ordering No.	Casting No.
72	10-27/32"	3/16"	5-5/32"	-	PN1950-2-GRATE	38144-8

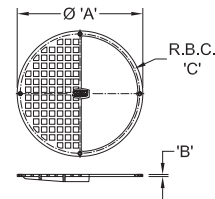

ZN1950 3/4 Grate						
Item No.	Diameter 'A'	Rim Thickness 'B'	R.B.C. 'C'	Open Area. Sq. In.	Ordering No.	Casting No.
73	10-27/32"	3/16"	5-5/32"	-	PN1950-3-GRATE	38144-6

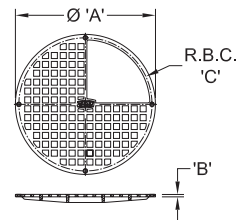

ZN1950 Full Grate with Center Opening						
Item No.	Diameter 'A'	Rim Thickness 'B'	R.B.C. 'C'	Open Area. Sq. In.	Ordering No.	Casting No.
74	10-27/32"	3/16"	5-5/32"	-	PN1950-4-GRATE	38144-4

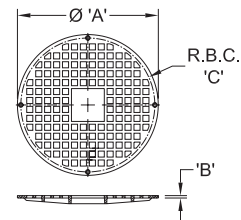

⚠ **WARNING:** Cancer and Reproductive Harm - [www.P65Warnings.ca.gov](http://www.P65Warnings.ca.gov)  
 ⚠ **ADVERTENCIA:** Cáncer y daño reproductivo - [www.P65Warnings.ca.gov](http://www.P65Warnings.ca.gov)  
 ⚠ **AVERTISSEMENT:** Cancer et effets néfastes sur la reproduction - [www.P65Warnings.ca.gov](http://www.P65Warnings.ca.gov)

Zurn Industries, LLC | Specification Drainage Operation  
1801 Pittsburgh Avenue, Erie, PA 16502, Ph. 855.663.9876

In Canada | Zurn Industries Limited  
7900 Goreway Drive, Unit 10, Brampton, Ontario L6T 5W6, Ph. 877.892.5216

[www.zurn.com](http://www.zurn.com)

Rev. -  
Date: 10/13/2021  
C.N. No. 144086  
Prod. | Dwg. No. FD137



# ROUND GRATE/COVER REPLACEMENTS

ZN1950 Solid Cover						
Item No.	Diameter 'A'	Rim Thickness 'B'	R.B.C. 'C'	Open Area. Sq. In.	Ordering No.	Casting No.
75	10-27/32"	3/16"	5-5/32"	-	PN1950-15-COVER	67612-1

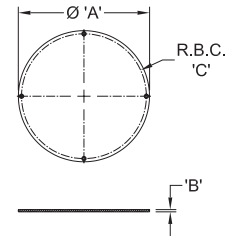

Z1960 Full Grate						
Item No.	Diameter 'A'	Rim Thickness 'B'	R.B.C. 'C'	Open Area. Sq. In.	Ordering No.	Casting No.
76	7-7/32"	1/4"	-	-	P1960-FULL-GRATE	54069-1

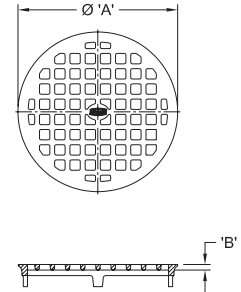

Z1960 Half Grate						
Item No.	Diameter 'A'	Rim Thickness 'B'	R.B.C. 'C'	Open Area. Sq. In.	Ordering No.	Casting No.
77	7-7/32"	1/4"	-	-	P1960-2-GRATE	54069-4

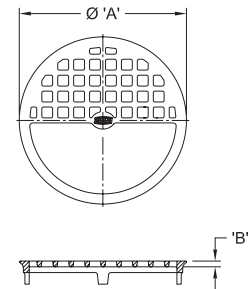

Z1960 3/4 Grate						
Item No.	Diameter 'A'	Rim Thickness 'B'	R.B.C. 'C'	Open Area. Sq. In.	Ordering No.	Casting No.
78	7-7/32"	1/4"	-	-	P1960-3-GRATE	54069-3

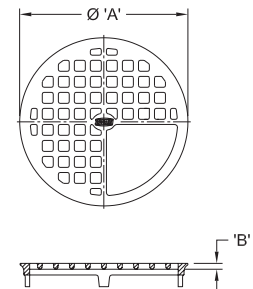

Z1960 Full Grate with Center Opening						
Item No.	Diameter 'A'	Rim Thickness 'B'	R.B.C. 'C'	Open Area. Sq. In.	Ordering No.	Casting No.
79	7-7/32"	1/4"	-	-	P1960-4-GRATE	54069-2

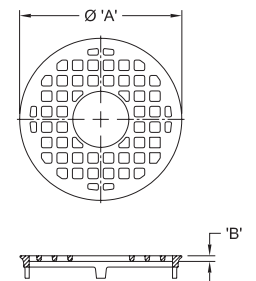

⚠ **WARNING:** Cancer and Reproductive Harm - [www.P65Warnings.ca.gov](http://www.P65Warnings.ca.gov)  
 ⚠ **ADVERTENCIA:** Cáncer y daño reproductivo - [www.P65Warnings.ca.gov](http://www.P65Warnings.ca.gov)  
 ⚠ **AVERTISSEMENT:** Cancer et effets néfastes sur la reproduction - [www.P65Warnings.ca.gov](http://www.P65Warnings.ca.gov)

Zurn Industries, LLC | Specification Drainage Operation  
1801 Pittsburgh Avenue, Erie, PA 16502, Ph. 855.663.9876

In Canada | Zurn Industries Limited  
7900 Goreway Drive, Unit 10, Brampton, Ontario L6T 5W6, Ph. 877.892.5216

[www.zurn.com](http://www.zurn.com)

Rev. -  
 Date: 10/13/2021  
 C.N. No. 144086  
 Prod. | Dwg. No. FD137



# ROUND GRATE/COVER REPLACEMENTS

## Z1960 Solid Cover

Item No.	Diameter 'A'	Rim Thickness 'B'	R.B.C. 'C'	Open Area. Sq. In.	Ordering No.	Casting No.
80	7-7/32"	1/4"	-	-	P1960-15-COVER-USA	54069-5

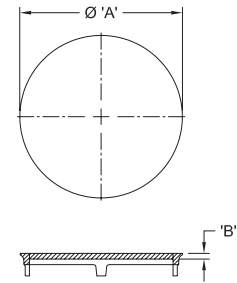

## ZN1960 Full Grate

Item No.	Diameter 'A'	Rim Thickness 'B'	R.B.C. 'C'	Open Area. Sq. In.	Ordering No.	Casting No.
81	7-5/8"	3/16"	3-15/32"	17	PN1960-GRATE	38147-2

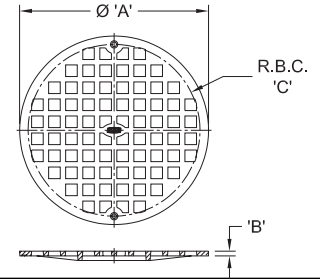

## ZN1960 Half Grate

Item No.	Diameter 'A'	Rim Thickness 'B'	R.B.C. 'C'	Open Area. Sq. In.	Ordering No.	Casting No.
82	7-5/8"	3/16"	3-15/32"	-	PN1960-2-GRATE	38855-1

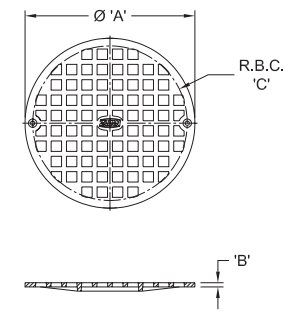

## ZN1960 3/4 Grate

Item No.	Diameter 'A'	Rim Thickness 'B'	R.B.C. 'C'	Open Area. Sq. In.	Ordering No.	Casting No.
83	7-5/8"	3/16"	3-15/32"	-	PN1960-3-GRATE	38854-1

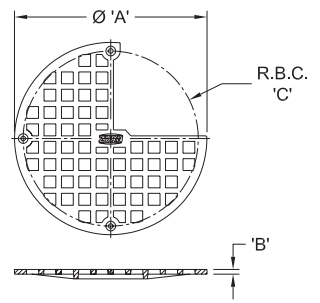

## ZN1960 Full Grate with Center Opening

Item No.	Diameter 'A'	Rim Thickness 'B'	R.B.C. 'C'	Open Area. Sq. In.	Ordering No.	Casting No.
84	7-5/8"	3/16"	3-15/32"	-	PN1960-4-GRATE	38147-4

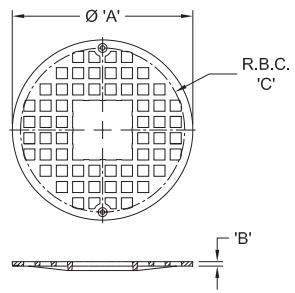

**⚠ WARNING:** Cancer and Reproductive Harm - [www.P65Warnings.ca.gov](http://www.P65Warnings.ca.gov)

**⚠ ADVERTENCIA:** Cáncer y daño reproductivo - [www.P65Warnings.ca.gov](http://www.P65Warnings.ca.gov)

**⚠ AVERTISSEMENT:** Cancer et effets néfastes sur la reproduction - [www.P65Warnings.ca.gov](http://www.P65Warnings.ca.gov)

Zurn Industries, LLC | Specification Drainage Operation  
1801 Pittsburgh Avenue, Erie, PA 16502, Ph. 855.663.9876

In Canada | Zurn Industries Limited  
7900 Goreway Drive, Unit 10, Brampton, Ontario L6T 5W6, Ph. 877.892.5216

[www.zurn.com](http://www.zurn.com)

Rev. -  
Date: 10/13/2021  
C.N. No. 144086  
Prod. | Dwg. No. FD137



# ROUND GRATE/COVER REPLACEMENTS

ZN1960 Solid Cover						
Item No.	Diameter 'A'	Rim Thickness 'B'	R.B.C. 'C'	Open Area. Sq. In.	Ordering No.	Casting No.
85	7-5/8"	3/16"	3-15/32"	-	PN1960-15-COVER-USA	67632-1

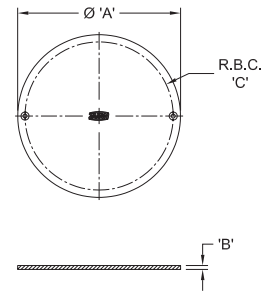

Z1970 Half Grate						
Item No.	Diameter 'A'	Rim Thickness 'B'	R.B.C. 'C'	Open Area. Sq. In.	Ordering No.	Casting No.
86	8"	7/16"	3-3/4"	-	P1970-2-GRATE	50570-13

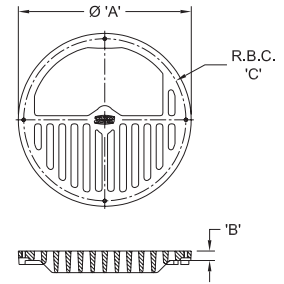

Z1970 3/4 Grate						
Item No.	Diameter 'A'	Rim Thickness 'B'	R.B.C. 'C'	Open Area. Sq. In.	Ordering No.	Casting No.
87	8"	7/16"	3-3/4"	-	P1970-3-GRATE	50570-17

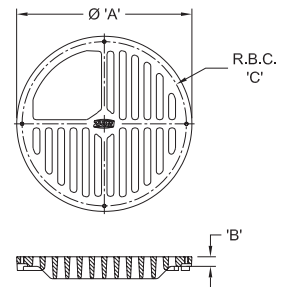

Z1970 Full Grate with Center Opening						
Item No.	Diameter 'A'	Rim Thickness 'B'	R.B.C. 'C'	Open Area. Sq. In.	Ordering No.	Casting No.
88	8"	7/16"	3-3/4"	-	P1970-4-GRATE	50570-21

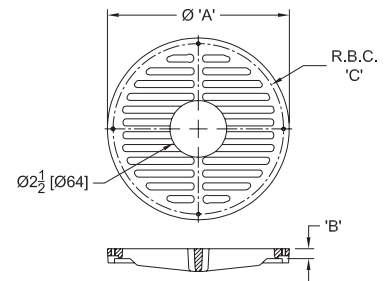

## ROOF DRAINS - FLUSH GRATE

Z100-FG, Z104-FG, Z107-FG						
Item No.	Diameter 'A'	Rim Thickness 'B'	R.B.C. 'C'	Open Area. Sq. In.	Ordering No.	Casting No.
89	12-1/2"	1/2"	4-13/16"	32.07	P100-FG-USA	57558-1

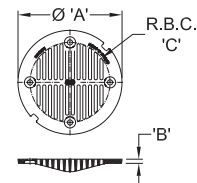

⚠ **WARNING:** Cancer and Reproductive Harm - [www.P65Warnings.ca.gov](http://www.P65Warnings.ca.gov)  
 ⚠ **ADVERTENCIA:** Cáncer y daño reproductivo - [www.P65Warnings.ca.gov](http://www.P65Warnings.ca.gov)  
 ⚠ **AVERTISSEMENT:** Cancer et effets néfastes sur la reproduction - [www.P65Warnings.ca.gov](http://www.P65Warnings.ca.gov)

Zurn Industries, LLC | Specification Drainage Operation  
1801 Pittsburgh Avenue, Erie, PA 16502, Ph. 855.663.9876

In Canada | Zurn Industries Limited  
7900 Goreway Drive, Unit 10, Brampton, Ontario L6T 5W6, Ph. 877.892.5216

[www.zurn.com](http://www.zurn.com)

Rev. -  
 Date: 10/13/2021  
 C.N. No. 144086  
 Prod. | Dwg. No. FD137



# ROUND GRATE/COVER REPLACEMENTS

Z100-FG-89, Z104-FG-89, Z107-FG-89						
Item No.	Diameter 'A'	Rim Thickness 'B'	R.B.C. 'C'	Open Area. Sq. In.	Ordering No.	Casting No.
90	13-1/16"	2-1/16"	4-13/16"	32.07	P100-FG-89-USA	57558-2

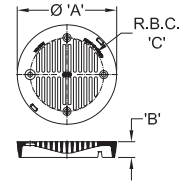

Z121-FG						
Item No.	Diameter 'A'	Rim Thickness 'B'	R.B.C. 'C'	Open Area. Sq. In.	Ordering No.	Casting No.
91	10-1/4"	5/8"	4-3/16"	23	P121-FG	62053-1

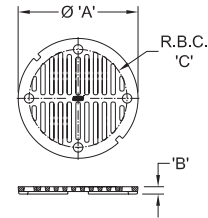

Z125-FG						
Item No.	Diameter 'A'	Rim Thickness 'B'	R.B.C. 'C'	Open Area. Sq. In.	Ordering No.	Casting No.
92	7-3/4"	9/16"	3-1/8"	12.8	P125-FG-USA	82177-1

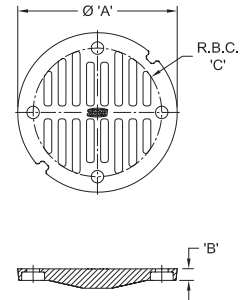

Z125-FG-89						
Item No.	Diameter 'A'	Rim Thickness 'B'	R.B.C. 'C'	Open Area. Sq. In.	Ordering No.	Casting No.
93	8-1/8"	2-1/16"	3-1/8"	12.8	821770021	82177-2

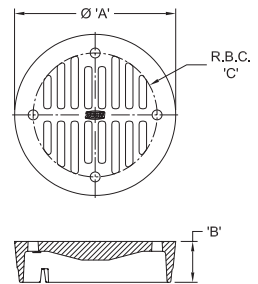

⚠ **WARNING:** Cancer and Reproductive Harm - [www.P65Warnings.ca.gov](http://www.P65Warnings.ca.gov)  
 ⚠ **ADVERTENCIA:** Cáncer y daño reproductivo - [www.P65Warnings.ca.gov](http://www.P65Warnings.ca.gov)  
 ⚠ **AVERTISSEMENT:** Cancer et effets néfastes sur la reproduction - [www.P65Warnings.ca.gov](http://www.P65Warnings.ca.gov)

Zurn Industries, LLC | Specification Drainage Operation  
 1801 Pittsburgh Avenue, Erie, PA 16502, Ph. 855.663.9876

In Canada | Zurn Industries Limited  
 7900 Goreway Drive, Unit 10, Brampton, Ontario L6T 5W6, Ph. 877.892.5216

[www.zurn.com](http://www.zurn.com)

Rev. -  
 Date: 10/13/2021  
 C.N. No. 144086  
 Prod. | Dwg. No. FD137